



802001	HYDROCITY 01 12+12	LIGHT SOURCE	LED COLOR*	LIGHT BEAM OPTIONS	LUMEN OUTPUT (lm)	LUMINOUS EFFICACY (lm/w)	COLORS OPTIONS
36 WATT 220-240V 50-60HZ ELECTRONIC IP66 6,10 KG UNIT GROSS WEIGHT		HIGH-POWER LED	3.000°K WARM-WHITE	ROTOSYMMETRICAL	3.456	96.00	TEXTURED GREY
				CYCLE ROUTE PEDESTRIAN			MATT WHITE (ON REQUEST)
				STREET			MATT BLACK (ON REQUEST)

\* OTHER LIGHT COLORS AVAILABLE ON REQUEST: ○ 4.000°K NEUTRAL-WHITE, ● BLUE



802002	HYDROCITY 01 24+24	LIGHT SOURCE	LED COLOR*	LIGHT BEAM OPTIONS	LUMEN OUTPUT (lm)	LUMINOUS EFFICACY (lm/w)	COLORS OPTIONS
72 WATT 220-240V 50-60HZ ELECTRONIC IP66 6,10 KG UNIT GROSS WEIGHT		HIGH-POWER LED	3.000°K WARM-WHITE	ROTOSYMMETRICAL	6.912	96.00	TEXTURED GREY
				CYCLE ROUTE PEDESTRIAN			MATT WHITE (ON REQUEST)
				STREET			MATT BLACK (ON REQUEST)

\* OTHER LIGHT COLORS AVAILABLE ON REQUEST: ○ 4.000°K NEUTRAL-WHITE, ● BLUE

## POLES & ACCESSORIES

### BURIED POLES

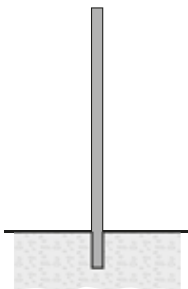

CODE	ARTICLE	HEIGHT MM.	DESCRIPTION
809901	CYLINDRICAL POLE 3,5 METERS TO BE BURIED	3.500	Cylindrical pole made in steel S235JR (UNI EN 10219) hot galvanized (UNI EN 1461), diameter 76 mm, thickness 4 mm. Phospho-chromatised and polyester powder coated. Total height including 500 mm to be buried into the ground. Includes IP54 cover plate 132x38 mm and terminal block in double insulation.
809902	CYLINDRICAL POLE 4,5 METERS TO BE BURIED	4.500	
809903	CYLINDRICAL POLE 5,5 METERS TO BE BURIED	5.500	
809908	ADAPTER DIAM. 76MM → 60MM		Adapter for pole diam. 76 mm, allow the diameter reduction to 60 mm

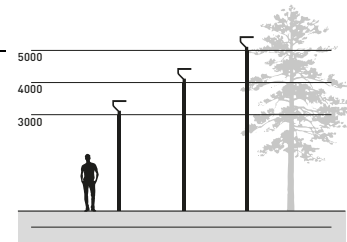

### POLES WITH BASE-PLATE

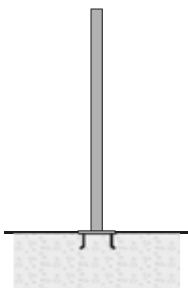

CODE	ARTICLE	HEIGHT MM.	DESCRIPTION
809904	CYLINDRICAL POLE 3 METERS WITH BASE-PLATE	3.000	Cylindrical pole made in steel S235JR (UNI EN 10219) hot galvanized (UNI EN 1461), diameter 76 mm, thickness 4 mm. Phospho-chromatised and polyester powder coated. With base plate dim. 250x250 mm, thickness 10 mm. Includes IP54 cover plate 132x38 mm and terminal block in double insulation.
809905	CYLINDRICAL POLE 4 METERS WITH BASE-PLATE	4.000	
809906	CYLINDRICAL POLE 5 METERS WITH BASE-PLATE	5.000	
809907	ANCHORAGE UNIT FOR BASE-PLATE		Base plate dim. 250x250 mm, thickness 3 mm, made in galvanized steel complete of nr. 4 anchorage threaded bolts
809908	ADAPTER DIAM. 76MM → 60MM		Adapter for pole diam. 76 mm, allow the diameter reduction to 60 mm





## 802001-02 HYDROCITY 01 LED

Round pole-top mounted luminaire for outdoor installation on a pole diam. 60 mm, single supporting arm, with downward light distribution. Phosphochromatised and polyester powder coated die-cast copper-free aluminium body, tempered safety glass, moulded silicone gasket and stainless steel screws. Built-in LED driver/s, with number of LEDs from 24 to 48 CREE XP-G3 LED. IP66 rating.

### Energy Label **A++**

- Material: high corrosion resistance die-cast copper-free aluminum body
- Coating: polyester powder coating with phosphochromating pre-finish
- NR. 24 -> 48 x 1.5W CREE "XP-G3" LED
- Electronic transformer 220/240V 50/60Hz included
- Stainless steel screws
- Silicone rubber gasket
- Tempered safety glass.
- 3 m neoprene power cable included

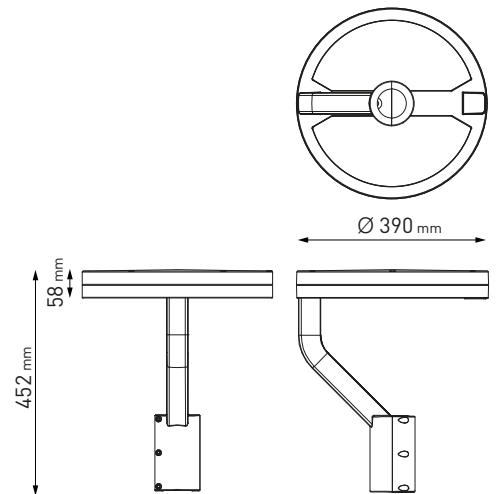

### AVAILABLE OPTICS:



ROTSYMMETRICAL



CYCLE ROUTE / PEDESTRIAN



STREET





## 802003..07 HYDROCITY 02 LED

Round pole-top mounted luminaire for outdoor installation on a pole diam. 60 mm, double supporting arm, with downward light distribution. Phosphochromatised and polyester powder coated die-cast copper-free aluminium body, tempered safety glass, moulded silicone gasket and stainless steel screws. Built-in LED driver/s, with number of LEDs from 12 to 48 CREE XP-G3 LED. IP66 rating.

### Energy Label **A++**

- Material: high corrosion resistance die-cast copper-free aluminium body
- Coating: polyester powder coating with phosphochromating pre-finish
- NR. 12 -> 48 x 1.5W CREE "XP-G3" LED
- Electronic transformer 220/240V 50/60Hz included
- Stainless steel screws
- Silicone rubber gasket
- Tempered safety glass.
- 3 m neoprene power cable included

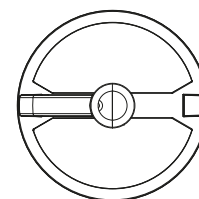

Ø 390 mm

58 mm  
452 mm

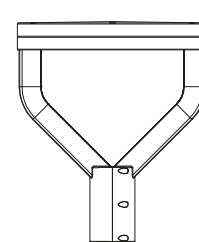
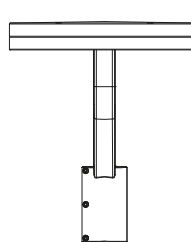

### AVAILABLE OPTICS:



ROTOSYMMETRICAL



CYCLE ROUTE / PEDESTRIAN



STREET











p.uk.<sup>®</sup>

